

**POORLY DAMPED ELECTROMECHANICAL OSCILLATION
IN THE 345 kV INTERCONNECTION BETWEEN ARGENTINA AND CHILE.
IDENTIFICATION BASED ON A SLIDING PRONY ANALYSIS.**

J.L. AGÜERO
IITREE-FI UNLP

R.D. MOLINA
CAMMESA

J.C BARBERO
IITREE-FI UNLP
Argentina

F. ISSOURIBEHERE
IITREE-FI UNLP

SUMMARY

Small signal stability problems are one of the major threats to grid stability and reliability. An unstable oscillatory mode can cause large-amplitude oscillations and may result in system breakup and large scale blackouts.

There is an existent and non-operating, 345 kV transmission line between Argentinean Interconnected System (SADI) and the Northern Interconnected System (SING), which is one of the two major electrical isolated power systems in Chile with current surplus capacity and ongoing renewable energy developments. In the past, this line was only dedicated to transmit power to Chile from a power plant located in Argentina but isolated from its power system.

Recently, there has been an increasing interest in restarting the operation of the 345 kV transmission line to allow the interconnected operation of both systems, SADI and SING, with growing power flows in both directions. Last year, the Company AES GENER (owner of the 345 kV transmission line and some generation plants in Argentina and Chile) received the authorization from both governments to start interconnection feasibility studies [5], to make interconnection tests and to develop operational procedures. Starting up the operation of the transmission line, in order to establish power transactions between both countries, requires the involvement of many energy market players like: system operators, transmission operators, energy policy makers, generation companies, consumers and governmental entities.

The "Instituto de Investigaciones Tecnológicas para Redes y Equipos Eléctricos" (IITREE) from La Plata National University, was responsible for performing power measurements, due to the fact that according to power system studies performed by the IITREE and the "Compañía Administradora del Mercado Mayorista Eléctrico S.A." (CAMMESA), a poorly damped electromechanical oscillation in the electrical power was expected.

KEYWORDS

Electromechanical oscillations – Interconnected Systems – Measuring system - Oscillations damping – Power plants - Prony analyses - Transmission system.

Jorge Luis Agüero: jla@iitree-unlp.org.ar

INTRODUCTION

Figure 1 shows the Argentinean Power System (SADI) meanwhile **Figure 2** shows the Chile North Power System (SING-Chile).

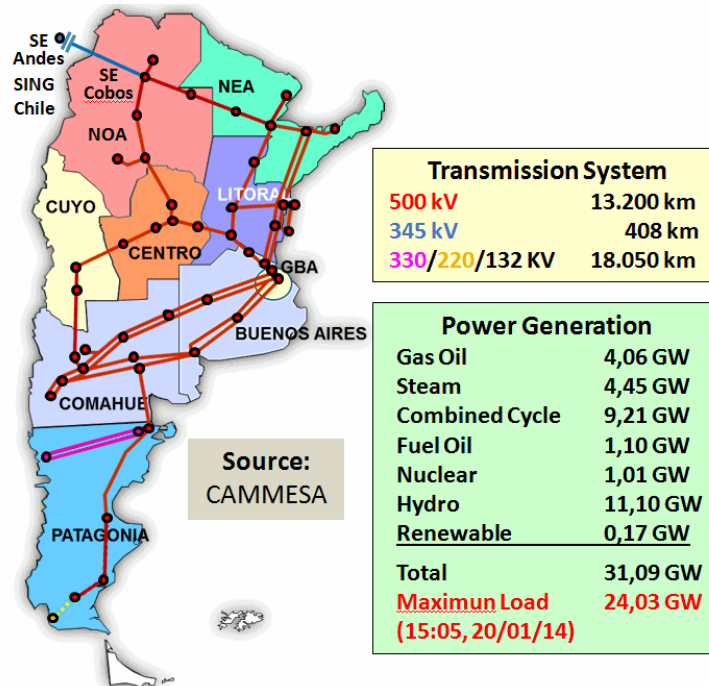

Figure 1. Argentinean Interconnected System (SADI).
345 kV line (blue) between Cobos (SADI-Argentina) and Andes (SING-Chile).

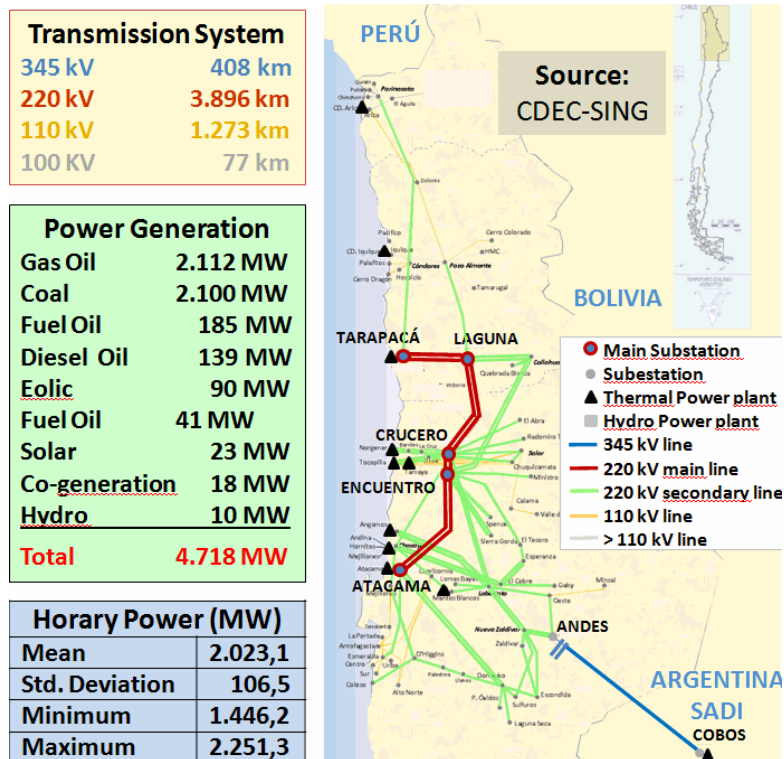

Figure 2. Chile North Power System (SING).
345 kV line (blue) between Cobos (SADI-Argentina) and Andes (SING-Chile).

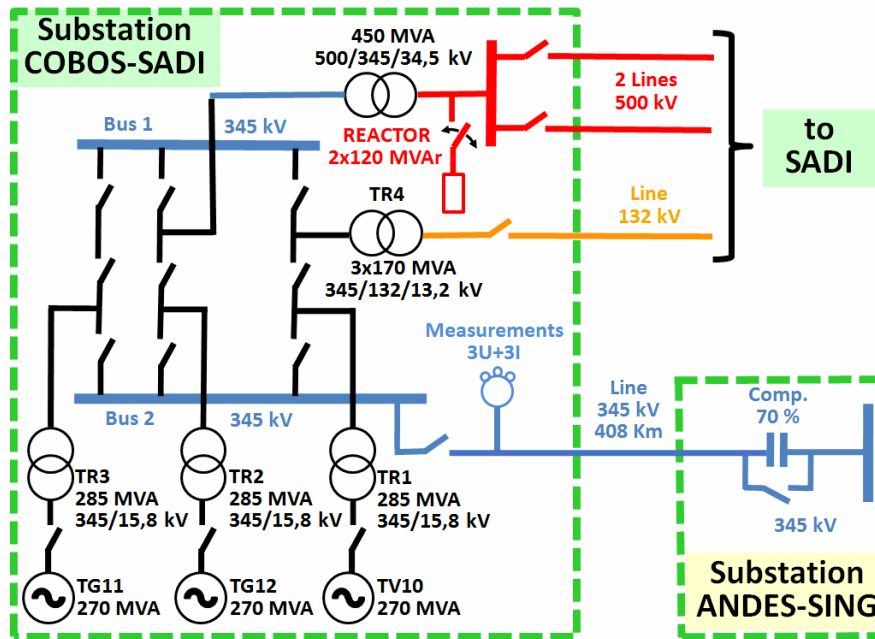

Figure 3: Substation Cobos with Termoandes Combined Cycle (GT11, GT12 y ST10), with 2x500 kV and 132 kV lines to SADI (Argentina), and 345 kV line of 408 Km to Substation Andes (SING-Chile).

The SING (Chile) and SADI (Argentina) Electrical Systems are linked by a 345 kV and 408 km long line, with a capacitive series compensation of 70 % located at SE Andes (SING), see **Figures 1 to 3**. This line has high mountain stretches.

Capacitive series compensation was disconnected to avoid any problems of sub-synchronous resonance on SING steam generating units.

These units have several rotating masses (generators, Exciter, stages of low - medium – high pressure turbine, etc.) mechanically coupled by shafts, and can present sub-synchronous frequencies of mechanical resonance (f_m) with very low mechanical damping (due to the low friction in axis stands).

These mechanical oscillation frequencies can be excited by complementary oscillations in power system ($f_m = 50 - f_e$) resulting in life loss due to fatigue in the axis, or breakaway if mechanical torque between the different parts of the shaft is too large.

In order to induce electromechanical oscillations, a 120 KVAR reactor was connected and disconnected. This reactor is located at 500 kV bus bar of SS Cobos (SADI), see **Figure 3**.

MEASURING SYSTEM AND TESTS MADE

The measurements were carried out in SS Cobos, Salta province, Argentina, where Termoandes power plant of AES Gener company is located, see **Figure 3**. It is composed by a combined cycle consisting of 2 Gas Oil turbines (TG11 and TG12) operating in closed cycle with a steam turbine (TV10).

Each one of these 3 generating units is of 270 MVA - 15.8 kV, and is connected to a 15.8/345kV - 285 MW step-up transformer.

The measurements were carried out at Cobos Substation, on the line of 345 kV, 408 Km, linking with SS Andes (SING); see "Measurements 3U+3I" in **Figure 3**.

Line voltages were measured in the secondary side of 345/0.115 kV Voltage Transformers, and line currents were measured in the secondary side of 1200/1 A Current Transformers, see **Figure 4 left**.

Another set of current transformers of 1/10 relation was used, just to amplify the measured currents to acceptable levels required by conventional Power Transducer, see **Figure 4 left**.

In addition, for measuring line currents, current clamps of 400 mV/A relation were used. These current clamps embraced 20 laps of the current transformer burden cable, obtaining a 20/1 amplification factor. Output voltages from these current clamps were connected to the inputs of a signal conditioning equipment designed and built by the IITREE, see **Figure 4 left**.

Line voltages measured in the secondary side of voltage transformers were also connected to the inputs of Signal Conditioning equipment from IITREE, see **Figure 4 right**.

One of the measured voltages was connected to the input of Frequency Deviation Transducer (0 Volt output at 50 Hz input), designed and built by the IITREE, with adjustable scale factor. Finally, the 6 output signals from the signal conditioning equipment (3 currents and 3 voltages), together with the outputs from conventional Power Transducer (Active and Reactive powers) and from a high sensitivity Frequency Deviation Transducer (10V/Hz), were connected as inputs of 8855 HIOKI commercial recorder equipment.

In short, the following magnitudes were measured at Cobos Substation:

- 3x345 kV voltage and current waveforms (1 ms sampling time).
- Active and Reactive Power from conventional P-Q transducer.
- Frequency Deviation from 50 Hz from Frequency Deviation transducer.

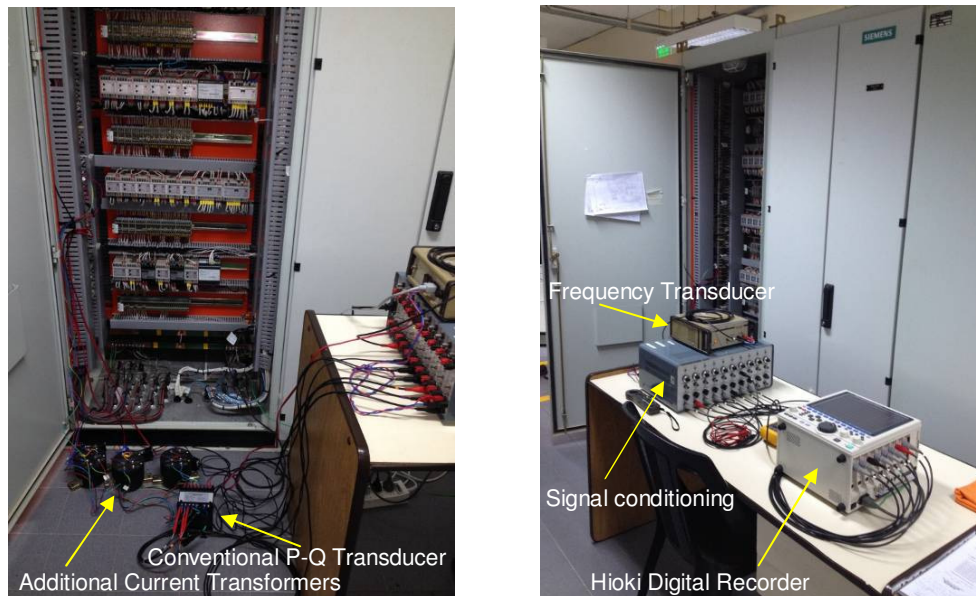

Figure 4: Measurement and registration equipment. SS Cobos 345 kV.

The following sequence of operations was carried out to perform tests:

- 09:19. Line 345 kV breaker closing from SADI side.
- 10:00. Line 345 kV breaker closing from SING side. SADI-SING interconnected.
- 10:40. SING to SADI power exporting of approx. 100 MW.
- 11:00. Reactor No 2 connection in SS Cobos 500kV.
- 11:12. Reactor No 2 disconnection in SS Cobos 500kV.
- 12:50. SADI to SING power exporting to approx. 150 MW.
- 13:22. Reactor No 2 connection in SS Cobos 500kV.
- 13:35. Reactor No 2 disconnection in SS Cobos 500kV.
- 13:52. Tests end. Line breakers opening of 345 kV line at both sides.

During the tests made on May 11th, 2014, 28 test records were taken. Records of each phase voltage and of each phase current were processed in Matlab in order to obtain the frequency and active power. These calculated magnitudes were contrasted with those obtained from the IITREE transducers, and no significant deviations were observed between both measurement procedures.

As an example, **Figure 5** shows records of Active Power and Frequency corresponding to the exportation of 100 MW from SADI to SING, meanwhile **Figure 6** shows records of Active Power and Frequency corresponding to the importation to SADI from SING of 150 MW.

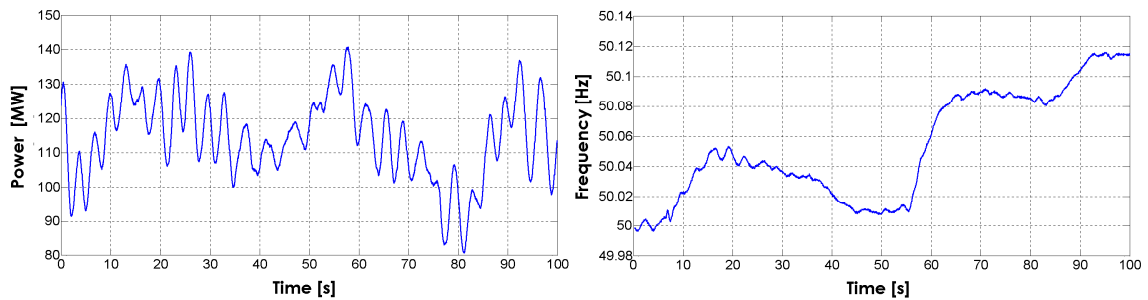

Figure 5: Power SADI → SING \cong 115 MW.

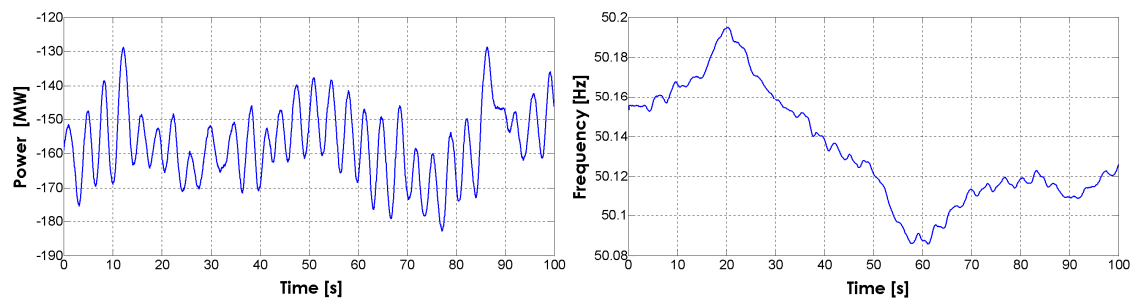

Figure 6: Power SING → SADI \cong 155 MW.

Whatever be the direction of the power exchanged between Argentina and Chile, the records show that there is an oscillation of about 0.3 Hz which is continuously excited. It could also be noted that oscillations decrease in amplitude when they are not excited again. It was verified that this behavior is due to the mining loads pattern in the SING. The oscillation is excited again each time a step change is produced in the SING demand.

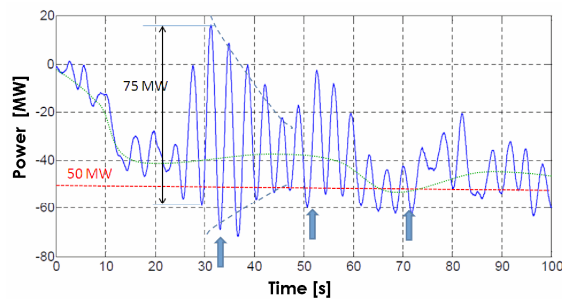

Figure 7: Power SING → SADI \cong 40 MW

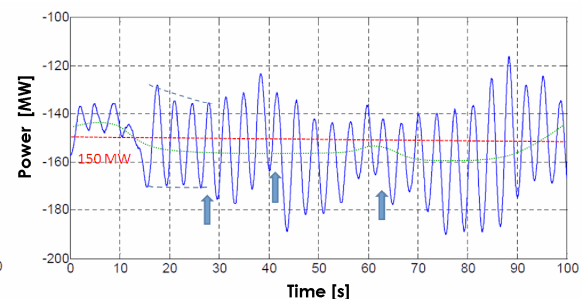

Figure 8: Power SING → SADI \cong 155 MW

In **Figures 7** and **8** the moments in which the oscillation is excited due to step change in the SING demand are indicated with "arrows".

Oscillation damping is appreciably reduced when the power exportation from SING to SADI is greater.

This continuously excited inter area oscillation mode, due to mining loads behavior in the SING, presented an additional challenge to refine the methodology for measuring the damping, frequency and amplitude of the power oscillation between SING and SADI.

PROCESSING OF MEASUREMENTS

A tool developed by the IITREE based on Prony method was used for the analysis of recorded electro-mechanical oscillations [1]. Especially designed for having the ability to identify the valid components (eigenvalues) of the analyzed waveform, this tool has been exhaustively verified with more than 800 transients records obtained from system event logs used for monitoring sub synchronous oscillations at 500 kV in SS Bahia Blanca [2-3].

Prony analysis allows rebuilding sampled transient signals as a combination of damped sinusoids, minimizing the quadratic error between the actual and the estimated signal, determining all parameters of each sinusoidal component present in the registered variables: amplitude, frequency and damping. This powerful tool performs Prony analysis over a sliding time window, in which the time step for calculation and the sliding window width are adjustable.

For the analysis of power exchange between Chile and Argentina, some adjustment parameters were incorporated into Prony analysis to better estimate the frequency and damping of the dominant oscillation mode.

To eliminate the slow power variations, probably due to governor influence for frequency control or due to power plant operator's action, tests records were filtered. The measured active power (black curve in **Figure 9**) was processed with a moving average filter, resulting in the red curve of **Figure 9**. This moving average filter, with a 10 second window width, was designed in order to remove frequency components below 0.1 Hz.

Subsequently, the moving average filter output was subtracted from the original measured active power, obtaining in this way a new active power signal (blue curve in **Figure 9**) more suitable for processing by means of Prony analysis.

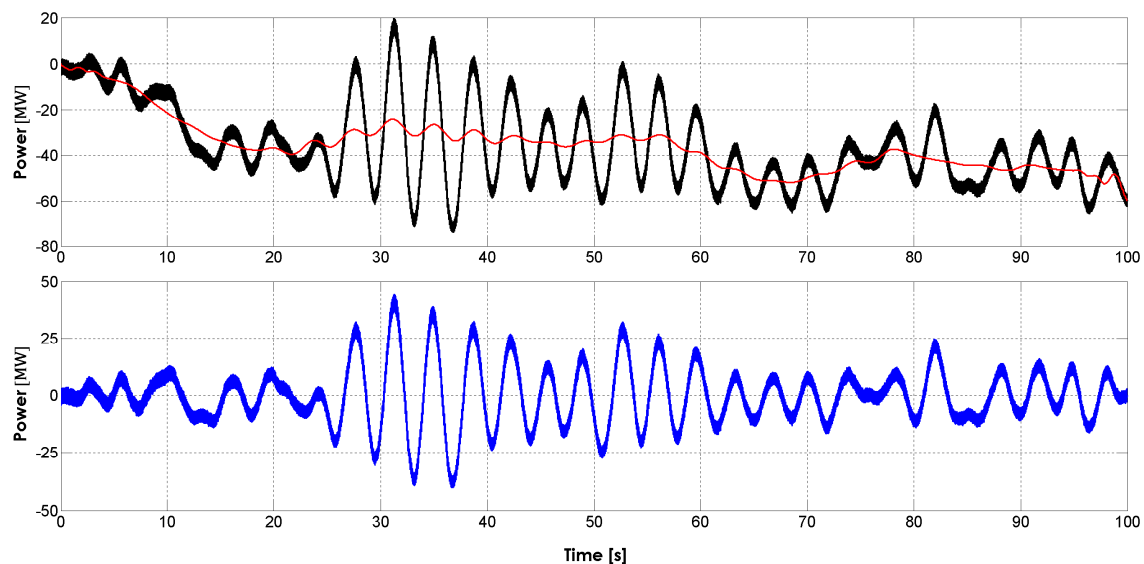

Figure 9: Power SADI \rightarrow SING \cong 40 MW.

Figure above: Original (black) and filtered (red) Active Power

Figure below: Filtered Active Power subtracted from original Active Power (blue).

For Prony analysis, which is intended to detect oscillation modes of approximately 0.3 Hz, an analysis window of 300 cycles of the fundamental frequency (50 Hz) width was used, that is a 6 second width window.

To analyze the behavior of the measured Electric Power (P) a sliding Prony analysis was performed every 20 milliseconds.

As an example, **Figure 10** and **Figure 11** show the Prony analysis results of measured active power of approximately 50 MW and 150 MW, respectively. In these cases, the power transfer was from SING to SADI.

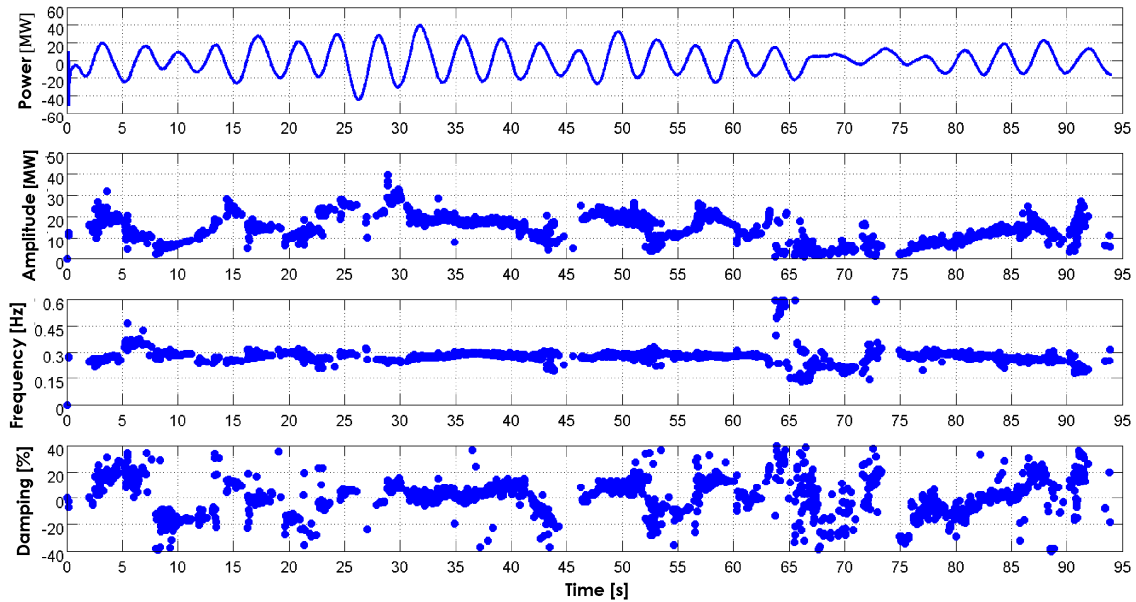

Figure 10: Prony Analysis. Power SING \rightarrow SADI \cong 50 MW.

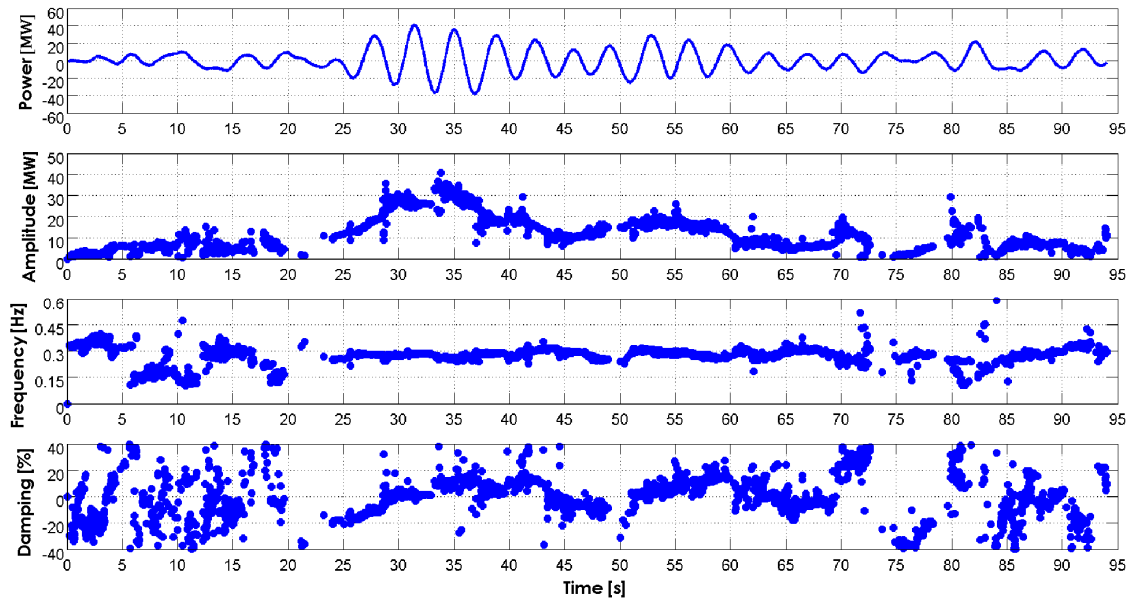

Figure 11: Prony Analysis. Power SING \rightarrow SADI \cong 150 MW.

The sliding Prony analysis shows that:

- The oscillation frequency is very close to the value of 0.3 Hz.
- The oscillation damping appears to be erratic because the dominant frequency oscillation mode is continuously excited. This behavior is due to the mining load pattern at SING.

However, there is a good correlation between the damping means value that could be seen in the trace of active power and the value estimated by the developed tool.

Then, the criteria for selecting in which part of the registry the Prony method should be applied were modified.

Since the dominant oscillation frequency is approximately 0.3 Hz, Prony analysis results are presented only for the following conditions:

- Frequency components between 0.25 and 0.35 Hz.
- Difference between maximum and minimum detected components between 0.25 and 0.35 Hz, higher than a given value (adjusted for each test record).
- Damping values between 0 % and 10 % were selected.

The Prony analysis results applying the new criteria to test records with power transfer from SING to SADI of approx. 50 MW and 150 MW are shown in **Figure 12** and **Figure 13** respectively, where it can be seen that:

- The oscillation frequency is about 0.3 Hz.
- The damping average value is about 3 % to 4%.

Although the dominant oscillation is excited continuously, after comprehensive processing of test records it is possible to conclude that in certain sections of the records it can be observed an oscillation frequency of 0.3 Hz and damping values between 3 to 4 %.

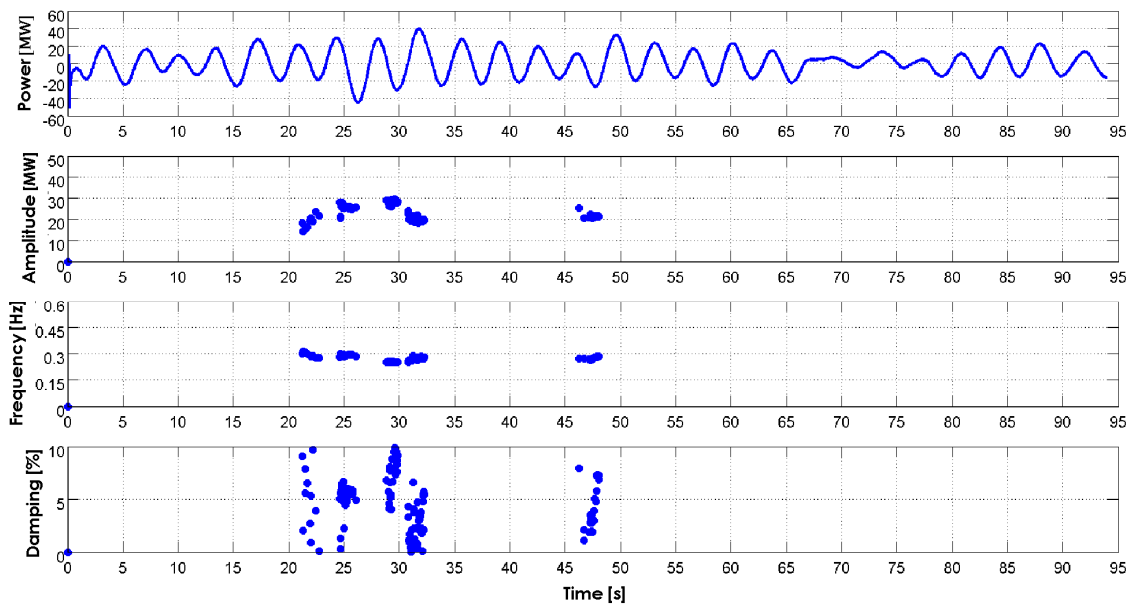

Figure 12: Prony Analysis applying new criteria. Power SING → SADI \cong 50 MW.

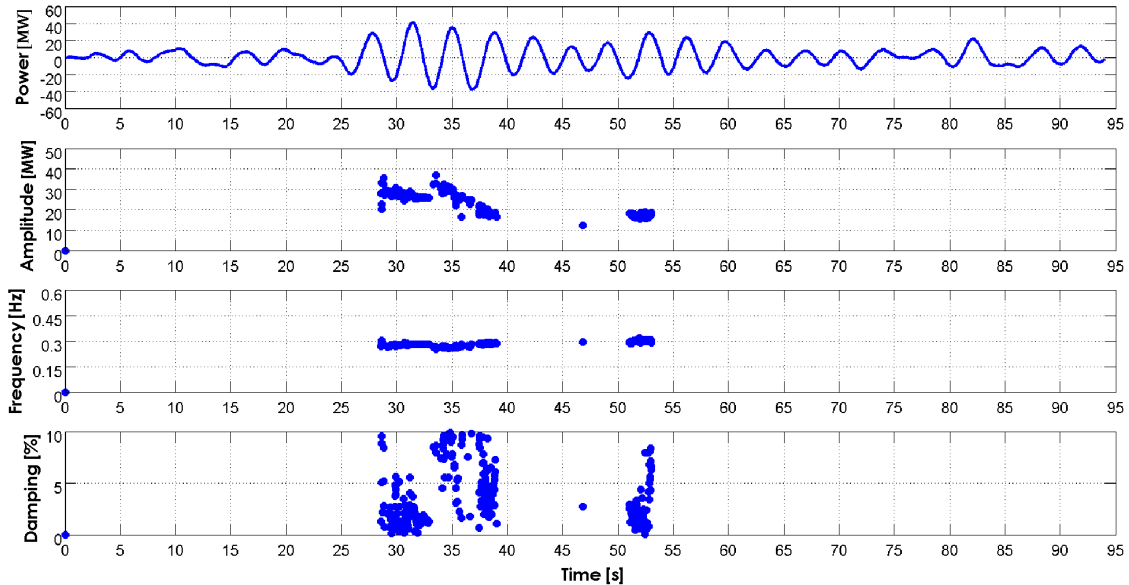

Figure 13: Prony Analysis applying new criteria. Power SING → SADI \cong 150 MW.

CONCLUSIONS

Based on the method of sliding Prony, the analysis tool developed has proven to be extremely useful to quantify the electromechanical oscillations that occur in transmission systems, and are observed mainly in the Electrical Power [3-4].

In the particular application of the Prony analysis method described in this paper, it is important to underline that the dominant electromechanical oscillation mode is continuously excited.

This situation causes difficulties for the accurate determination of the oscillating power parameters, particularly in the case of damping factor. This tool was also successfully used to analyze sub-synchronous oscillations in the Argentinean Interconnected System [2].

BIBLIOGRAPHY

- [1] P.F. Ribeiro “Time-Varying Waveforms Distortions in Power Systems”. (John Wiley & Sons).
- [2] J.A. Nizovoy, J.L. Alonso, A.C. Alvarez, L.M. Bouyssede “SSR Studies in Argentina for the Bahía Blanca Generating Plant” (International Power System Transients Conference, Seattle, USA, 23 to 27 June 1997).
- [3] P.E. Issouribehere, J.C. Barbero, F. Issouribehere, J. Rodríguez “Análisis de Oscilaciones Subsíncronas derivadas de fallas en Sistemas de 500 kV. Experiencias de aplicación del Método de Prony” (XIV ERIAC, Ciudad del Este, Paraguay, 22 to 26 May 2011).
- [4] J.L. Agüero, F. Issouribehere, J.C. Barbero, R.D. Molina “Determinación de los modos de oscilación electromecánicos en la interconexión SADI-SING a partir de registros de ensayos” (XVI ERIAC, Puerto Iguazú, Argentina, 17 to 21 May 2015).
- [5] F. Gallego, R.D. Molina “Factibilidad técnica de la interconexión SING (Chile)-SADI (Argentina)” (XVI ERIAC, Puerto Iguazú, Argentina, 17 to 21 May 2015).